

MAXIMATOR®

maximum pressure

Technical Data Sheet

S15D

» Oil service

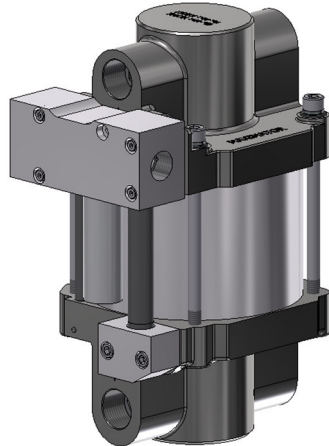
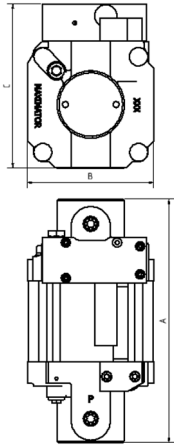

S15D

double acting, single air drive head

Technical Data:

Air drive pressure: 1 - 10 bar / 14.5 - 145 psi

Calculated working pressure: 160 bar / 2320 psi

Pressure ratio: 1:16

Displacement volume/double stroke: 56.6 cm³ / 3.45 cu.inch

Connections:

Inlet: 3/4" BSP

Outlet: 3/4" BSP

Air drive: 1/2" BSP

Maximum operating temperature: 60°C

Net weight: 14.5 kg

Pressure and flow performances, please see enclosed graph.

Wetted materials of construction:

Top cap: 0.7050

Air cylinder: 3.3206

Seal package: Polyurethane, NBR

Pump Body: 0.7050

HP Piston: 1.4112

Approximate Dimensions:

A: 260 mm

B: 135 mm

C: 175 mm

Available Options:

Special inlet and outlet ports, i.e. NPT: S15D-NPT

Special seal material to handle special fluids on request.

Available Accessories:

Air control units with filter pressure regulator, control pressure gauge and shut off valve: S15D with C1.5

To protect the pump against excessive outlet pressures or to limit the outlet pressure, a safety valve can be fitted to the air control unit in the air drive line. S15D with C1.5 / SV-air (The required outlet pressure has to be indicated.)

Please consult factory for more information. All technical and dimensional information subject to change. All General Terms and Conditions of sale, including limitations of our liability, apply to all products and services sold.

Leistungsdiagramm/Performance Graph S 15 D

Prüfflüssigkeit/Test Liquid: Wasser-Öl-Emulsion/Water Oil Emulsion ca. 1 - 10 cst

