



Air driven high pressure pumps

M, M...D, M...-C, MO, MO...D, M...-2, M...-3, M...-ECO, M...-HL, S, S...D, S...-SS, G, G...D, G...-C, G...-2, MSF, GSF, GPD, GPD...-2, GX, DPD

Installation and operating manual

Key information!
Follow the manual for safe and proper use.
Keep the manual near the machine for later reference.

MAXIMATOR GmbH
Lange Straße 6
99734 Nordhausen
Germany
Phone: +49 3631 9533-0
e-mail: info@maximator.de
Internet: www.maximator.de

Warranty and liability:

As a general rule, the “General Terms and Conditions” of Maximator GmbH shall apply. These terms and conditions are available at <http://www.maximator.de>.

Warranty and liability claims shall not be accepted if they can be attributed to one or more of the causes mentioned in this manual or explicitly stipulated below:

- Any use other than the intended use indicated in this manual
- Improper commissioning, operation or maintenance
- Operation with faulty safety equipment or incorrectly installed safety equipment and safeguards
- Failure to observe the commissioning, operation and maintenance instructions in this manual
- Insufficient monitoring of wear parts
- Wear on seals, guiding elements, etc. due to ageing and operation

31.08.2023 Translation of the Original

© Copyright 2023 Maximator GmbH - All rights reserved

Contents

1	General information	5
1.1	Information regarding this manual	5
1.2	Order code	5
1.3	Rating plate.	6
1.4	Explanation of symbols	7
1.5	List of abbreviations and formula signs used	8
1.6	Qualification of the personnel	8
2	Safety and protection measures	10
2.1	Personal protective equipment.	10
2.2	Signs and labels.	10
2.3	Work and danger zone.	11
2.4	Non obvious hazards	12
2.5	Residual risks.	12
2.5.1	Start-up and shut down	12
2.5.2	Risk of injury posed by noise	13
2.5.3	Hazardous operating fluids.	13
3	Product description.	14
3.1	Design and function.	14
3.2	Intended use	18
3.3	Foreseeable misuse	18
3.4	Misuse	18
3.5	Ports.	18
3.6	Technical specifications	19
3.6.1	Operating conditions	19
3.6.2	Dimensions and weight	22
3.6.3	Performance values	22
3.6.4	Service life	23
4	Transport, packaging and storage	24
4.1	Dimensions and weight	24
4.2	Delivery	24
4.3	Packaging	24
4.4	Storage.	24
5	Installation	26

Contents

5.1	Prerequisites for installation	26
5.2	Install the high-pressure pump.	26
5.3	Installation of connecting lines.	27
5.3.1	Connecting the drive air	28
5.3.2	Control air connection.	28
5.3.3	Connecting the inlet line and outlet line.	28
5.3.4	Connecting a separate bleed pipe	28
5.3.5	Exhaust silencer installation.	28
5.4	Commissioning	28
5.4.1	Prerequisites for commissioning	28
5.4.2	Commissioning	30
6	Operation.	31
6.1	Prerequisites for operation	31
6.2	Normal, safe operation	31
6.3	Abnormal situations during operation	31
6.4	Signs indicating the product is no longer safe to use	31
6.5	Put the pumps in a safe state.	32
7	Maintenance	33
7.1	Maintenance intervals.	33
7.2	Maintenance work	34
7.2.1	System inspection.	35
7.2.2	Leak-testing the connections	36
7.2.3	Checking screw fittings and connecting lines for damages	36
7.2.4	Cleaning the pumps	37
7.2.5	Leak detection	38
7.2.6	Lubricating the pump	39
7.2.7	Checking screw connections at the pump and connecting elements.	40
7.2.8	Repairing the pumps.	40
7.3	Spare parts and consumables	41
7.4	Accessories and special tools	41
7.5	Customer service	42
8	Troubleshooting.	43
8.1	Drive side.	44
8.2	High pressure side.	45
9	Removal and disposal.	46
9.1	Prerequisites for removal and disposal.	46

9.2	Removal	46
9.3	Disposal	47
10	Use in explosion-prone zones	48
10.1	General information	48
10.2	Temperature class	49
10.3	Operation and maintenance	49
10.4	Summary of ignition hazards	50
	Appendix	51

1 General information

1.1 Information regarding this manual

Maximator compressed air-driven high-pressure pumps can be used for a variety of applications. They are used to deliver oil, water, and other fluids, and pressurise them to high pressures. This manual applies to all compressed air-driven pump types with the following designations: M, M...D, M...-C, MO, MO...D, M...-2, M...-3, M...ECO, M...HL, S, S...D, S...SS, G, G...D, G...-C, G...-2, MSF, GSF, GPD, GPD...-2, GX, DPD, and a serial number higher than 21055000.

The general drawing provided is an integral part of this manual and must always be kept along with it.

1.2 Order code

The order code for the respective high-pressure pump consists of the designation of the pump type, and the variant code attached to it. In the designation of the pump type, the preceding letters indicate the pump series, e.g. M, MO, or G series.

1.3 Rating plate

The rating plate is located on the drive unit of the high-pressure pump and contains the following information:¹:

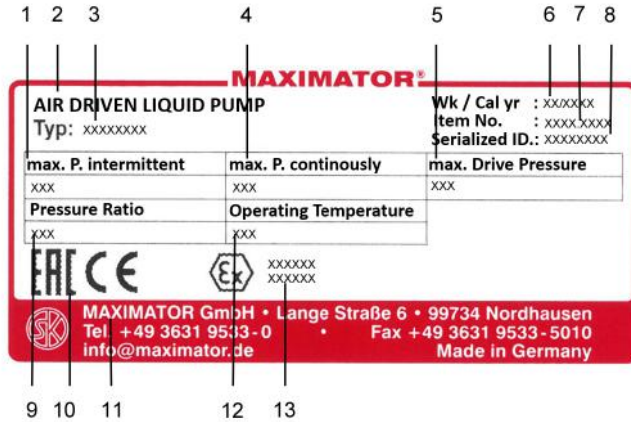

Fig. 1-1 High-pressure pump rating plate

- | | | | |
|---|---|----|----------------------------------|
| 1 | Maximum short-time operating pressure | 8 | Serial number |
| 2 | High-pressure pump | 9 | Pressure ratio |
| 3 | Type (specifications from the order code) | 10 | EAC label |
| 4 | Maximum constant drive pressure | 11 | Manufacturer contact information |
| 5 | Maximum drive pressure | 12 | Operating temperature range |
| 6 | Calendar week/year of manufacture | 13 | ATEX label |
| 7 | Article number | | |

¹ Individual pumps may have different rating plates, e.g. made of metal

1.4 Explanation of symbols



DANGER

This combination of symbol and signal word indicates a hazardous situation which - if not avoided - may lead to severe injuries or death.



WARNING

This combination of symbol and signal word indicates a potentially hazardous situation which - if not avoided - may lead to severe injuries or death.



CAUTION

This combination of symbol and signal word indicates a potentially hazardous situation which - if not avoided - may lead to light or minor injuries.

NOTICE

This combination of symbol and signal word indicates a potentially hazardous situation which - if not avoided - may lead to property damage or damage to the environment.



This symbol characterises contents and instructions for the intended use in potentially explosive areas.



This symbol highlights useful tips and recommendations as well as information for efficient and trouble-free operation.

1.5 List of abbreviations and formula signs used

Abbreviation	Description
Fig.	Figure
ATEX	EU explosion prevention directive
CE	EU mark of conformity
DGRL	EU pressure equipment directive (PED)
EAC	Eurasian economic union mark of conformity
EPL	Equipment Protection Level
CET	Central European Time
PPE	Personal protective equipment
Tab.	Table

Tab. 1-1 List of abbreviations

Formula symbol	Description
i	Pressure ratio
p_B	Operating pressure
p_L	Drive pressure
p_A	Primary pressure of the media
V_{stroke}	Stroke volume
n_{sp}	Strokes at standstill pressure
T	Temperature

Tab. 1-2 Formula symbol

1.6 Qualification of the personnel

Qualified personnel are required to work on and with the Maximator high-pressure pump safely and properly. Allowing unqualified personnel to work on the high-pressure pump or enter the danger zone creates hazards which could lead to death, severe injuries and significant property damage.

General information

Qualifications	System design	Transport and storage	Installation	Commissioning	Operation	Tooling and set-up	Cleaning	Repair and maintenance	De-installation	Operator
Understands the general mode of operation			x		x	x				x
Understands the detailed mode of operation	x			x				x		
Able to read and comprehend work-related documents					x	x	x			x
Able to read and comprehend work-related drawings/plans/documents	x		x	x				x	x	
Possesses comprehensive technical expertise	x	x	x	x	x	x	x	x	x	
Familiar with the activity-based safety labels utilised					x					
Familiar with the technical safety labels utilised		x	x	x	x	x	x	x	x	
Able to identify and adjust safety features				x		x		x		
Able to identify the risks specific to the work and comply with appropriate protective measures					x					
Able to identify the risks specific to the work and derive appropriate protective measures		x	x	x		x	x	x	x	
Able to identify and interpret the risks specific to the work and derive appropriate protective measures	x									
Knows and understands the relevant standards, directives and regulations and is able to apply them	x	x								x

Tab. 1-3 Qualification of the personnel

2 Safety and protection measures

The following sections stipulate the residual risks associated with the product, even when used as intended. In order to reduce the risk of personal injuries and material damage, and to prevent hazardous situations, you must observe the safety information listed in this section and the warnings in all other sections of this manual.

2.1 Personal protective equipment

Personal protective equipment (in other sections also referred to as PPE) protects personnel from occupational safety and health hazards while at work.

Wearing personal protective equipment may be required during work on the product. Wherever possible, this personal protective equipment is listed in these instructions for the individual work steps.

However, detailed specifications of the required protective equipment can only be determined with full knowledge of the system. The required personal protective equipment should therefore be determined by the user.

2.2 Signs and labels

The following signs are found on the high-pressure pump.

Over time, labels can become unrecognisable due to dirt or other causes. As a result, hazards cannot be identified, or necessary operating indications cannot be followed. Resulting errors can lead to severe injuries or death.

Keep the labels in good, legible condition and replace any damaged labels.

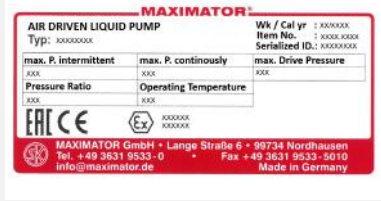
Signs and labels	Graphic display
<p>Rating plate: The rating plate is affixed to the drive unit of the high-pressure pump. The rating plate indicates the operating characteristics of the high-pressure pump.</p>	 <p>The image shows a red-bordered rating plate for a MAXIMATOR AIR DRIVEN LIQUID PUMP. It contains the following information:</p> <ul style="list-style-type: none"> MAXIMATOR logo at the top. AIR DRIVEN LIQUID PUMP title. Wk / Cal yr: 1 6000000 Item No.: 1 0000.0000 Serialized ID.: 00000000 Type: 00000000 max. P. intermittent: 0000 max. P. continuously: 0000 max. Drive Pressure: 0000 Pressure Ratio: 0000 Operating Temperature: 0000 EAC and CE certification marks. Ex certification mark. MAXIMATOR GmbH contact information: Lange Straße 6 • 99734 Nordhausen, Tel. +49 3631 9533-0, Fax +49 3631 9533-5010, info@maximator.de. Made in Germany at the bottom.

Tab. 2-1 Overview of labels

2.3 Work and danger zone

The danger zone comprises the entire area surrounding the product. The hazards associated with the product and the danger zone depend on the application and the installation location. The danger zone should therefore be determined by the user.

During assessment, check the following leak points according to the respective pump type:

1) MSF, GSF, G250-2 and higher, GX, GPD, DPD:

Leak point	Leak type	Leak source
Bleed port HP side	Minor release	High-pressure seal
Bleed port HP side	Minor release	Rod seal drive side
Bleed port HP side	Unexpected	Defective high-pressure seal
Bleed port HP side	Unexpected	Defective rod seal drive side

Tab. 2-2 Danger zone of leak points MSF, GSF, G250-2 and higher, GX, GPD, DPD

2) -ECO, -HL, -C (except double-acting):

Leak point	Leak type	Leak source
Ventilation port	Minor release	Piston seal drive side
Ventilation port	Minor release	Loose screw connection
Ventilation port	Unexpected	Defective high-pressure seal
Ventilation port	Unexpected	Defective piston seal drive side

Tab. 2-3 Danger zone of leak points -ECO, -HL, -C (except double-acting)

3) All high-pressure pumps not listed under 1 and 2:

Leak point	Leak type	Leak source
Silencer	Minor release	High-pressure seal
Silencer	Unexpected	Defective high-pressure seal

Tab. 2-4 Danger zone of leak points for all high-pressure pumps not listed under 1 and 2

In addition, the following applies to all high-pressure pumps:

Leak point	Leak type	Leak source
Pump head / HP cylinder	Unexpected	Defective pump head
Pump head / HP cylinder	Unexpected	Defective HP cylinder
Pump head / HP cylinder	Unexpected	Seals on the pump head or HP cylinder
Connection screw fitting	Unexpected	Loose screw connection
Connection screw fitting	Unexpected	Defective screw connection
Connecting line drive / HP	Unexpected	Connecting line
Connecting line drive / HP	Unexpected	Fitting
Connecting line drive / HP	Unexpected	O-ring
Drive housing parts	Unexpected	Seal in drive unit

Tab. 2-5 Danger zone of leak points for all high-pressure pumps

2.4 Non obvious hazards

Using asphyxiant operating fluids, e.g. nitrogen, can lead to severe injuries or death by asphyxiation. Assess the risk for the equipment in the risk assessment. The following are some potential corrective actions:

- Operate the high-pressure pump in an adequately ventilated space.
- Check the high-pressure pump for leaks on a regular basis.
- Ensure that lines are connected in such a way as to remain leak-tight for a long time.
- If necessary, use connecting lines to remove the escaping operating fluids.

2.5 Residual risks

2.5.1 Start-up and shut down

During the restoration of the pneumatic energy supply, the high-pressure pump may start up unexpectedly. This can lead to severe injuries or death.

Assess the risk for the equipment in the risk assessment.

There is no command device for safe shut-down (E-stop). This can lead to severe injuries or death.

Assess the risk for the equipment in the risk assessment.

2.5.2 Risk of injury posed by noise

The noise level emitted in the work area depends on the mounting and application.

Assess the risk for the equipment in the risk assessment.

2.5.3 Hazardous operating fluids

Improper use of operating fluids can lead to serious accidents resulting in death.

Assess the risk for the equipment in the risk assessment.

Active leaks can lead to serious accidents resulting in death.

Assess the risk for the equipment in the risk assessment.

3 Product description

3.1 Design and function

Structure

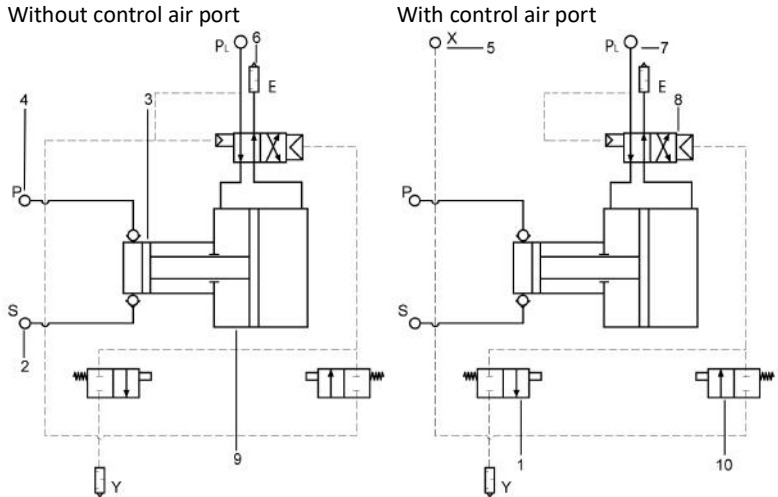

Tab. 3-1 Schematic diagram of a single-acting high-pressure pump

- | | | | |
|---|-----------------------|----|---------------------------|
| 1 | Pilot valve lower cap | 6 | Exhaust port (E) |
| 2 | Inlet port (S) | 7 | Drive air inlet (P_L) |
| 3 | High-pressure piston | 8 | Spool valve |
| 4 | Outlet port (P) | 9 | Air piston |
| 5 | Control air port (X) | 10 | Pilot valve top cap |

Function description

The operating principle of a compressed air-driven hydraulic pump is similar to the one of a pressure intensifier. Low pressure is applied to the large area of the air piston (9) which applies high-pressure to the small area of the high-pressure piston (3).

The piston of the high-pressure pump carries out oscillating movements until the standstill pressure is reached. In doing so, the high-pressure piston delivers and pressurises the pumped fluid by means of the check valves into the inlet port (2) and outlet port (4). The outlet pressure results from the set drive pressure and volume flow.

Product description

The continuous supply is achieved by means of an internally controlled directional valve, the spool valve (8). The spool valve alternately guides the drive fluid to the two sides of the air piston. The spool valve is controlled via two directional valves, the pilot valves (1; 10), which are operated mechanically by the air piston in its stop positions. The pilot valves vent the operating area of the spool valve.

An equilibrium of forces on the drive and high-pressure side is generated as soon as the standstill pressure is reached. The high-pressure pump stops and no longer consumes drive fluid. A pressure drop on the high-pressure side or a pressure increase on the drive side result in an automatic restart of the high-pressure pump while the pumped fluid is pressurised until an equilibrium of forces is restored.

In high-pressure pumps equipped with a control air port, the operating area of the spool valve will only be vented if control air is applied. If no control air is applied, the high-pressure pump will stop in the respective end position.

The individual high-pressure pump designs are shown below:

- Single-acting

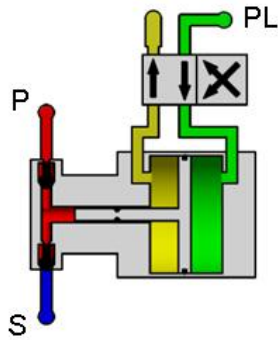

- Double-acting

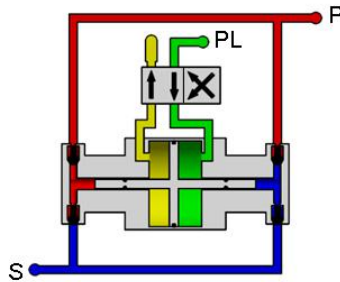

- Single-acting with two air pistons

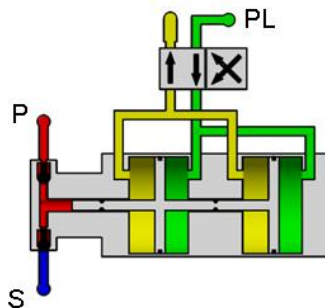

Product description

- Double-acting with two air pistons

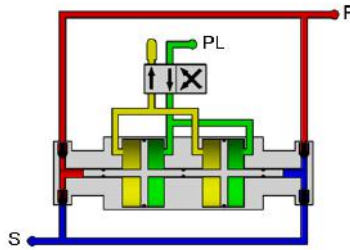

- Single-acting with three air pistons

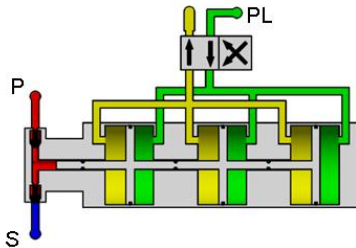

- Double-acting with one high-pressure piston

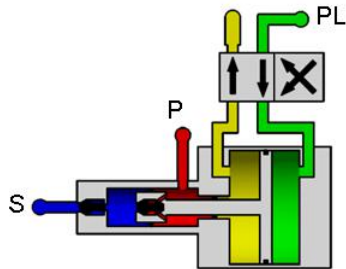

3.2 Intended use

Within their technical limits, high-pressure pumps are used to deliver and pressurise adequate types of fluids.

The compressed air-driven high-pressure pump is intended to be installed into a system. It must only be operated if all residual risks have been assessed as part of the risk assessment of the system.

If the high-pressure pump bears an ATEX label and comes with a declaration of conformity, it is designated for use in corresponding potentially explosive areas.

3.3 Foreseeable misuse

The product may only be used in accordance with the indications in this manual.

The product cannot be used for:

- sealing containers
- producing / processing food with direct contact
- producing pharmaceutical products in direct contact

3.4 Misuse

Unauthorised modifications or technical changes to the product may lead to accidents with serious or fatal injuries.

Never carry out unauthorised modifications or technical changes to the product!

3.5 Ports

Comply with the connected load specifications for all interface connections. Refer to the enclosed general drawing for the connection ports available on the respective high-pressure pump.

The following interfaces are standard on the high-pressure pumps:

Drive air inlet "P_L"

Input of drive fluid.

Inlet port "S"

Input of operating fluid.

Outlet port "P"

Output of operating fluid.

Exhaust port "E"

Output of expanding drive fluid.

Product description

Control air port "X"

Port for control air. The high-pressure pump will only operate if the control air connection is pressurised. The pressure of the control air must always be larger or equal to the drive pressure to ensure flawless function. The same requirements regarding compressed air quality apply to the control air as to the drive air.

Spool valve "V1" ventilation port

Ventilation and bleeding of the spool valve. The port must not be obstructed.

Pilot valve "Y" exhaust port

Bleeding of the spool valve actuator chamber. An air pulse escapes here after each stroke. The port must not be obstructed.

This port can be used to connect a stroke counter.

Bleed port high-pressure side "Z"

Discharge of the leakage from the high-pressure unit and the pneumatic drive. A bleed pipe can be connected.

Ventilation port on the back side of the piston pneumatic drive "V2"

Ventilation and bleeding of the piston back chamber and discharge of the leakage of the high-pressure unit. The port must not be obstructed.

3.6 Technical specifications

3.6.1 Operating conditions

Ambiant conditions

Specification	Value	Unit
Temperature range	-20 to +60	°C
Installation area	protected against climatic exposure	

Tab. 3-2 Ambient conditions

Operating fluids

Specification	Value	Unit
Operating temperature, minimum ^a	-20	°C
Operating temperature, maximum ^b	+60	°C
Purity class as per ISO 4406	19/16/13	[-]
Particle size, max.	100	µm

a. Depending on the design of the high-pressure pump. Refer to the general drawing provided or rating plate

b. Depending on the design of the high-pressure pump. Refer to the general drawing provided or rating plate

Tab. 3-3 Operating fluids

The high-pressure pump can be used with any operating fluids which do not chemically or physically corrode the high-pressure pump materials. The operating fluids should not pose any danger to the personnel. The high-pressure pump is not appropriate for use with unstable, ignitable or oxidising operating fluids. The materials used can be found on the enclosed general drawing. Certain high-pressure pump designs can be suitable for other operating fluids. If you are unsure regarding the use of a special fluid, please don't hesitate to contact Maximator.

Information regarding specific operating fluid categories can be found in the following. This information is intended as support for the selection and assessment of the individual pump variants. This information does not replace a comprehensive risk assessment for the system. In individual cases, other solutions may be more advantageous.

Toxic operating fluids:

In many pump types, the operating fluid may be released via the silencer during operation. To reduce hazards, pumps with high-pressure bleed ports can be used here.

Flammable operating fluids:

In many pump types, the operating fluid may be released via the silencer during operation. To reduce hazards, pumps with high-pressure bleed ports can be used here.

Liquid CO₂ and other liquid gases:

In order to avoid malfunctions during the pumping process, it is important to avoid the formation of gas bubbles when the operating fluid is sucked in. This may be achieved, for example, by operating the pump with primary pressure and using the C variant.

Demineralised water:

Depending on the degree of purity of the demineralised water and the requirements for the cleanliness of the pump, various options are possible here. In many cases, special pump materials can be used. Let Maximator advise you on the selection of a suitable pump.

Product description

Drive fluids (based on ISO 8573-1)

Specification	Value	Unit
Drive pressure P_L , minimum	1	bar
Drive pressure P_L , maximum	10	bar
Drive fluid	Compressed air ^a or nitrogen	
Drive fluid temperature, min.	-20	°C
Drive fluid temperature, max.	+60	°C
Maximum degree of purity of the oil	5 (Class 4)	mg/m ³
Maximum particle count 0.1 - 0.5 μ m Size	not indicated (Class 3)	units
Maximum particle count 0.5 - 1.0 μ m Size	90,000 (Class 3)	units
Maximum particle count 1.0 - 5.0 μ m Size	1,000 (Class 3)	units
Maximum solid particle concentration	5 (Class 6)	mg/m ³
Maximum pressure Dew point in case of humidity ^b	+3 (Class 4)	°C
Maximum particle size	10	μ m

a. Maximator high-pressure pumps generally do not need a compressed air oiler as they are treated with special grease during installation. However, after the first time an oiler is used, the drive fluid should always be oiled, as the oil washes out the special grease. The oil in the oiler must be in accordance with DIN 51524 - ISO VG 32.

b. For drive fluid temperature of 20 °C . Other values may be required depending on the temperature of the drive fluid.

Tab. 3-4 Drive fluid requirements

Drive with compressed air

Maximator high-pressure pumps generally do not need a compressed air oiler as they are treated with special grease during installation. However, after the first time an oiler is used, the drive fluid should always be oiled. In case a compressed air oiler is used, the oil must comply with DIN 51524 - ISO VG 32 specifications.

If dry or very dry compressed air is used, a high-pressure pump with FEC option will be recommended.

Drive with nitrogen

As standard, all Maximator high-pressure pumps can be operated with nitrogen. This is equivalent to operation with dry or very dry compressed air.

Drive with other gases

The high-pressure pump can be used with any drive fluids which do not chemically or physically corrode the high-pressure pump materials. The drive fluids must not pose any danger to the personnel. The high-pressure pump is not appropriate for use with unstable, ignitable or oxidising drive fluids. The high-pressure pump materials are indicated on the general drawing. Certain high-pressure pump designs can be suitable for other drive fluids. If you are unsure regarding the use of a special fluid, please don't hesitate to contact Maximator.

3.6.2 Dimensions and weight

The dimensions and weight of the high-pressure pump are indicated on the general drawing.

3.6.3 Performance values

The performance values of the high-pressure pump can be found on the rating plate and general drawing.

For more detailed information on the respective high-pressure pump, including characteristic curve and connection diagram, please refer to the respective data sheet on the Maximator website at <http://www.maximator.de>.

Permissible leakage rate

With most pump models, the leakage cannot be determined via the HP seal without major effort. The leak test procedure to be used for this purpose is described in the maintenance section.

The following limit value applies to the high-pressure pumps:

Criteria	Limit value	Unit
Strokes at standstill pressure n_{sp}	1	1/min

Tab. 3-5 Permissible leakage rate in as-delivered condition

The following limit value must be observed to ensure operational safety.

Criteria	Limit value	Unit
Strokes at standstill pressure n_{sp}	2	1/min

Tab. 3-6 Permissible leakage for operational safety

Product description

Based on the following assumptions, a rough estimate of the amount of leakage can be made from the determined strokes at standstill pressure n_{sp} .¹

- The strokes n_{sp} determined at standstill pressure and closed pressure port P result solely from external leakage via the high-pressure seal.
- The leakage at standstill pressure and the leakage at the operating point of the pump are comparable.
- No primary pressure is applied at inlet port S.

The amount of leakage can be roughly estimated:

$$\text{Leakage} = V_{\text{stroke}} * n_{sp}$$

3.6.4 Service life

The service life of the product depends on the conditions of use. The service life should therefore be determined and defined by the user.

¹ The actual amount of leakage at the operating point depends on other factors, and can in reality deviate significantly from the value determined in this way.

4 Transport, packaging and storage

4.1 Dimensions and weight

The dimensions and weight of the high-pressure pump are indicated on the general drawing.

4.2 Delivery

Scope of delivery

Designation	Quantity
High-pressure pump	1
Installation and operating manual including Declaration of Incorporation and EU Declaration of Conformity	1
General drawing	1

Tab. 4-1 Scope of delivery

4.3 Packaging

The individual packages are packed according to the conditions expected for transport. Separate packaging should be used for transport and dust protection. The packaging is supposed to protect the individual components against transport damage, corrosion and other damage up to its place of use.

Do not remove the dust protection until shortly before installation.

Dispose of the packaging materials in an environmentally friendly manner.

4.4 Storage

Note the following with regard to package storage:

- Do not store the packages out of doors.
- Keep the packages dry and dust-free.
- Do not expose the packages to corrosive fluids.
- Keep the packages protected from sunlight.
- Prevent mechanical vibrations.
- Maintain a storage temperature of -20°C to +60°C.
- The relative humidity should not exceed 60%.

Storage instructions in addition to the specifications mentioned here may be attached to the packages.

Maintenance during storage

Even under the aforementioned storage conditions, the high-pressure pump cannot be stored indefinitely.

- If in storage for longer than 3 months: Inspect the packaging and the high-pressure pump for damage on a regular basis.
- Replace all the seals at least every 6 years.
- If stored longer than two years, the lubricants used in the high-pressure pumps may turn bad and sticky. This may result in malfunctions of the high-pressure pump. After long storage periods, always check the pumps for proper function before use, or carry out maintenance on the pump accordingly.

5 Installation

5.1 Prerequisites for installation

Comply with the manual and the general drawing of the product.
In addition, the following conditions apply:

- The product must be free of damage.
- Do not expose the product to any vibrations.
- The product must be easily accessible from all sides.
- Do not expose the product to any external heat or radiation sources.
- Install the product in a clean environment.

5.2 Install the high-pressure pump



WARNING

Risk of injury posed by improper installation of the high-pressure pump!

Improper installation of the high-pressure pump may lead to accidents resulting in severe or fatal injuries.

- ▶ Pressures permissible on the drive side at the outlet of the high-pressure pump must not exceed the maximum permissible operating pressure of the high-pressure pump.



WARNING

Risk of injury posed by improper installation of the high-pressure pump!

Improper installation of the high-pressure pump may lead to accidents resulting in severe or fatal injuries.

- ▶ The high-pressure pumps are designed to be self-priming. Operation with primary pressure is only possible upon consultation with Maximator.

The product is enclosed in dust-protection packaging. Do not remove this packaging until shortly before installation. Dispose of this packaging in an environmentally friendly manner.

Attach the high-pressure pump to the fastening holes provided using screws or bolts with a strength of at least 4.6. Determine the adequate screw or bolt size using the enclosed general drawing.

The preferred installation position is vertical.

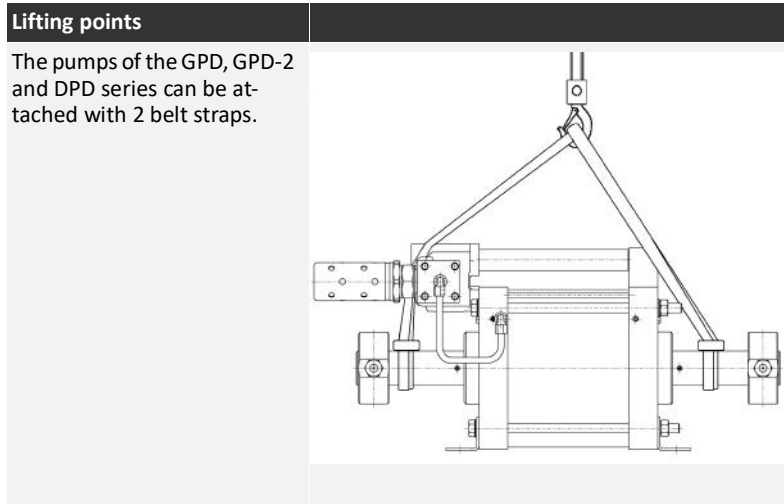

Tab. 5-1 Lifting points

5.3 Installation of connecting lines



WARNING

Risk of injury posed by improper installation of the connecting lines!

Improper installation of the high-pressure pump may lead to accidents resulting in severe or fatal injuries.

- ▶ Connecting lines must be hermetically sealed long-term.
- ▶ Check connecting lines for leaks.
- ▶ Do not obstruct leakage ports.
- ▶ Replace any faulty components immediately.

The high-pressure pump is delivered without any connection screw fittings or connecting lines. For this purpose, observe the specifications in section “Connections” and on the general drawing. To prevent malfunctions, the cross-sections of the connecting lines must be designed for the corresponding volume flows.

A failure of the check valves may lead to accidents resulting in severe or fatal injuries.

A return flow of the fluid via the check valves must not lead to the maximum operating pressure in the supply line being exceeded.

The leakage rate thresholds must be observed.

Assess the risk for the equipment in the overall risk assessment.

5.3.1 Connecting the drive air

Connect the connecting line for the drive air to the drive air port (P_L). Observe the connection specifications on the general drawing.

5.3.2 Control air connection

Connect the connecting line for the control air, if applicable, to the control air port (X) of the high-pressure pump. Observe the connection specifications on the general drawing.

5.3.3 Connecting the inlet line and outlet line

Connect the inlet and outlet lines to the corresponding high-pressure pump ports (S and P) in an appropriate manner. Observe the connection specifications on the general drawing.

5.3.4 Connecting a separate bleed pipe

If a bleed port (Z) is provided, a bleed line can be installed here in an appropriate manner. Observe the connection specifications on the general drawing.

5.3.5 Exhaust silencer installation

If the exhaust air connection pipe of the high-pressure pump is not installed separately, the enclosed exhaust air silencer must be installed at the corresponding port.

5.4 Commissioning

5.4.1 Prerequisites for commissioning

Observe the manual and general drawing of the product. In addition, the following conditions must be met:

- The product must be free of damage.
- The product must be securely attached.
- Do not expose the product to any vibrations.
- The product must be easily accessible from all sides.
- Do not expose the product to any external heat or radiation sources.
- Install the product in a clean environment.



WARNING

Risk of injury posed by improper installation of the high-pressure pump!

Improper installation of the high-pressure pump may lead to accidents resulting in severe or fatal injuries.

- The high-pressure pumps are designed to be self-priming. Operation with primary pressure is only possible upon consultation with Maximator.
-



WARNING

Risk of injury posed by improper installation of the connecting lines!

Improper installation of the high-pressure pump may lead to accidents resulting in severe or fatal injuries.

- ▶ Connecting lines must be hermetically sealed long-term.
 - ▶ Check connecting lines for leaks.
 - ▶ Do not obstruct leakage ports.
 - ▶ Replace any faulty components immediately.
-



WARNING

Risk of injury posed by improper installation of the high-pressure pump!

Improper installation of the high-pressure pump may lead to accidents resulting in severe or fatal injuries.

- ▶ The system-specific standstill pressure of the high-pressure pump must not exceed the maximum permitted operating pressure.
 - ▶ The system-specific standstill pressure must be calculated before commissioning.
 - ▶ Secure the system accordingly if necessary.
-



WARNING

Risk of injury posed by improper installation of the high-pressure pump!

Pumps with manual emergency operating mode may generate an output pressure during manual operation which is higher than the permissible operating pressure. Improper installation of the high-pressure pump may lead to accidents resulting in severe or fatal injuries.

- ▶ The system-specific standstill pressure of the high-pressure pump must not exceed the maximum permitted operating pressure.
 - ▶ It is not possible to provide security through calculation.
 - ▶ A corresponding pressure protection on the system side behind the pump is required.
-

Prior to commissioning the high-pressure pump, the system-specific standstill pressure must be calculated. The standstill pressure of the high-pressure pump is calculated for the respective pump type using the following formulas:

Pump type and operating conditions	Standstill pressure
Operation of all pump types without primary pressure of the media	$p_B = p_L \cdot i$
Operation of double-acting pump types with primary pressure of the media: ^a	$p_B = p_L \cdot i + p_A$

a. For example, with the use of CO₂-/liquid gas

Legend:

- p_L = drive pressure
- p_B = standstill pressure
- i = transmission ratio
- p_A = primary pressure of the media

5.4.2

Commissioning



WARNING

Risk of injury due to extreme temperatures!

The surfaces of the product can be very hot or very cold. This can lead to accidents resulting in severe injuries or death.

- ▶ Before working on the product, please ensure that the product is at ambient temperature.

Details about how to start up the high-pressure pump is described in the following: In order to reduce the risk of injury posed to the operator, appropriate goggles should be worn during this activity.

- 1) Check all connections for proper installation.
- 2) Check all connecting lines for mechanical damage.
- 3) If applicable, open the control air line.
- 4) Slowly open the compressed air line of the compressed air line system to the high-pressure pump.
 - The high-pressure pump automatically starts to deliver.



We recommend slowly increasing the pressure of the drive air to keep the stress on the pump components low during commissioning.

The stroke frequency of the high-pressure pump is kept low this way. Otherwise, there will be operating phases with very high stroke frequencies during the ramp-up phase until the required operating pressure is reached.

A low stroke frequency also helps the high-pressure pump when bleeding the inlet line.

6 Operation

6.1 Prerequisites for operation

Follow the manual and general drawing for the product.
In addition, the following conditions are required:

- The product must be free of damage.
- The product must be securely attached.
- The product is not exposed to any vibrations.
- The product is not exposed to any external heat or radiation sources.
- A risk assessment has been compiled for the system, and all basic health and safety requirements have been met.

6.2 Normal, safe operation



WARNING

Risks of sustaining injuries are posed by improper handling of operating fluids!

Improper handling of operating fluids can lead to accidents resulting in severe injuries or death.

- ▶ Comply with the safety data sheets of the operating fluids.
 - ▶ Dispose of operating fluid residues in an appropriate manner.
 - ▶ Notify other people (for example: repair department) of hazardous operating fluids.
-

6.3 Abnormal situations during operation

Refer to the general system documentation for measures to consider or implement in case of abnormal operation.

6.4 Signs indicating the product is no longer safe to use

The following signs indicate that the high-pressure pump is no longer safe to use.
In such cases, the high-pressure pump must be put into a safe state immediately.

- Leaking high-pressure seal
- Leaking pump head
- Leaking high-pressure cylinder
- Leaking high-pressure connections
- Leaking drive unit
- Visible damage

6.5 Put the pumps in a safe state

In a safe state, the high-pressure pump is depressurised on the drive end and the high-pressure side. The steps necessary in order to achieve a safe state depend on the installation position in the system. Refer to the general system documentation for the required actions.

7 Maintenance

7.1 Maintenance intervals

To ensure safe and smooth operation, the high-pressure pump must be checked regularly and serviced, cleaned or repaired as necessary. The individual maintenance activities are described in the following section.

Maximator recommends the intervals listed below. These intervals are calculated based on 1,300,000 strokes / year.

The required maintenance intervals depend on the system and application. The intervals must be adjusted based on the given conditions of use.

Activity	before and after each use	daily	weekly	monthly	quarterly	semi-annually	annually	as needed
System inspection			x					
Leak-testing the connections			x					
Check screw fittings and connecting lines for damage			x					
Clean the high-pressure pump					x			
Check fastening elements and connecting elements					x			
Leak detection						x		
Repair the high-pressure pump								x
Lubricating the pump ^{ab}								

a. Only some pump types must be lubricated. The pump types concerned have a lubrication nipple and a respective notice on the general drawing.

b. The lubrication intervals can be found on the general drawing of the pump.

Tab. 7-1 Maintenance intervals

7.2 Maintenance work



WARNING

Risks of sustaining injuries are posed by improper handling of operating fluids!

Improper handling of operating fluids can lead to accidents resulting in severe injuries or death.

- ▶ Comply with the safety data sheets of the operating fluids.
- ▶ Dispose of operating fluid residues in an appropriate manner.
- ▶ Notify other people (for example: repair department) of hazardous operating fluids.



WARNING

Risk of injury due to extreme temperatures!

The surfaces of the product can be very hot or very cold. This can lead to accidents resulting in severe injuries or death.

- ▶ Before working on the product, please ensure that the product is at ambient temperature.



WARNING

Risk of injury due to inappropriate spare parts!

Making repairs using inappropriate spare parts can lead to accidents resulting in severe injuries or death.

- ▶ Only use spare parts that comply with Maximator specifications.



WARNING

Risk of sustaining injury posed while handling lubricants!

Handling lubricants may lead to accidents resulting in severe or fatal injuries.

- ▶ Use protective gloves and goggles.
- ▶ Avoid contact with the skin.
- ▶ Observe the safety data sheet of the lubricant accordingly.



WARNING

Risk of injury due to dangerous system status!

Maintenance and inspection activities sometimes require that the high-pressure pumps be operated with modified connection cables or without safety equipment. The operation of the high-pressure pump may lead to accidents with serious or fatal injuries.

- ▶ When performing work, ensure that no hazards are created!
-

7.2.1 System inspection

The following section explains how to check the pump for proper function:

	Description
Qualifications	Operating the system
Type of maintenance	Check
Interval	weekly
PPE	<ul style="list-style-type: none">– Safety goggles– Hearing protection
1.	Close outlet P and adjust p_B to a value customary for the system. The high-pressure pump automatically stops when reaching the standstill pressure and no longer carries out any strokes (dwell time 60 s).
2.	Relieve p_L . p_B does not drop by more than 10 % (dwell time 30 s).
3.	Set p_L to approx. 50 % of the value from the first step and slowly relieve p_B . The high-pressure pump starts up automatically.
4.	If the inspection does not reveal any abnormalities, it will be safe to continue using the high-pressure pump. In case of abnormalities, consult with the maintenance staff.

7.2.2 Leak-testing the connections

The following section explains how to check the connections for leaks:

	Description
Qualifications	Operating the system
Type of maintenance	Check
Interval	weekly
Prerequisites	<ul style="list-style-type: none"> – The high-pressure pump is easy to access. – All connections are pressurised.
PPE	<ul style="list-style-type: none"> – Safety goggles
Tools	<ul style="list-style-type: none"> – Torch – Cleaning cloth – Leak detection spray
1.	<p>Check connections for leaks.</p> <p>Use leak detection spray on the drive unit.</p>
2.	<p>If the inspection does not reveal any abnormalities, it will be safe to continue using the high-pressure pump.</p> <p>In case of abnormalities, consult with the maintenance staff.</p>

7.2.3 Checking screw fittings and connecting lines for damages

The following section explains how to inspect the screw fittings and connecting lines:

	Description
Qualifications	Operating the system
Type of maintenance	Check
Interval	weekly
Prerequisites	<ul style="list-style-type: none"> – The high-pressure pump is easy to access. – The high-pressure pump is depressurised.
Tools	<ul style="list-style-type: none"> – Torch – Cleaning cloth
1.	<p>Visual inspection of the screw fittings and connecting lines. Is there any visible damage or other visible signs of wear?</p>
2.	<p>If the inspection does not reveal any abnormalities, it will be safe to continue using the high-pressure pump.</p> <p>In case of abnormalities, consult with the maintenance staff.</p>

7.2.4 Cleaning the pumps

The following section explains how to clean the high-pressure pump:

	Description
Qualifications	Clean the high-pressure pump
Type of maintenance	Cleaning
Interval	quarterly
Prerequisites	<ul style="list-style-type: none">– The high-pressure pump is easy to access.– The high-pressure pump is depressurised.
Tools	<ul style="list-style-type: none">– Cotton cleaning cloth– Solvent-free cleaning product
1.	<div style="background-color: #f4a460; padding: 5px;"> WARNING</div> <p>Risk of injury due to static electricity</p> <p>Cleaning the high-pressure pump may cause a charge to accumulate in non-conductive layers. Explosions with severe injuries or death can result.</p> <ul style="list-style-type: none">▶ Only clean the high-pressure pump with a damp cloth.▶ Use cotton cleaning cloth. <hr/> <p>Clean the high-pressure pump.</p>
2.	<p>The cleaning process has been successful if:</p> <ul style="list-style-type: none">– The high-pressure pump is free of dirt.– ports and silencers are free of dirt.

7.2.5 Leak detection

The following section explains how to inspect for leaks:

	Description
Qualifications	Repair and service the high-pressure pump
Type of maintenance	Check
Interval	semi-annually
Prerequisites	The high-pressure pump is easy to access.
PPE	<ul style="list-style-type: none"> – Safety goggles – Hearing protection
Tools	<ul style="list-style-type: none"> – Torch – Cleaning cloth – Leak detection spray
1.	Check connections for leaks. Use leak detection spray on the drive unit.
2.	Shut off the pump at outlet port P.
3.	Pressurise to the standstill pressure.
4.	Determine, how many strokes the pump carries out at standstill pressure n_{sp} (dwell time 60 s).
5.	Relieve p_L . p_B does not drop by more than 10 % (dwell time 30 s).
6.	Set p_L to approx. 50 % of the value from the first step and slowly relieve p_B . The high-pressure pump starts up automatically.
7.	<ul style="list-style-type: none"> – relieve p_L – relieve p_B – disassemble the spool valve – examine the spool valve – Are the seals worn? – Is it still adequately lubricated?
8.	<p>The inspection has been successful if:</p> <ul style="list-style-type: none"> – all leak tests have been carried out successfully. – the spool valve is OK. <p>If the high-pressure pump does not pass the inspection, it must be repaired or replaced.</p>

7.2.6 Lubricating the pump

The following section explains how to lubricate the pump ¹:

	Description
Qualifications	Repair and service the high-pressure pump
Type of maintenance	Maintenance
Interval	Notice on the general drawing
Prerequisites	<ul style="list-style-type: none">– The high-pressure pump is easy to access.– The high-pressure pump is depressurised.
Tools	<ul style="list-style-type: none">– Torch– Cleaning cloth– Grease gun– Lubricant according to the information on the drawing
1.	Remove lubricant residues in the area of the leakage ports.
2.	Connect the grease gun and insert lubricant until it emerges from the leakage ports.
3.	Remove lubricant residues in the area of the leakage ports.
4.	The maintenance will be deemed successful if the lubricant has been properly refilled.

¹ Only some pump types have to be lubricated. The pump types concerned have a lubrication nipple and a respective notice on the general drawing.

7.2.7 Checking screw connections at the pump and connecting elements

The following section explains how to inspect the screw connections and connecting elements at the pump:

	Description
Qualifications	Repair and service the high-pressure pump
Type of maintenance	Check
Interval	quarterly
Prerequisites	<ul style="list-style-type: none"> – The high-pressure pump is easy to access. – The high-pressure pump is depressurised.
Tools	Torque spanner
1.	Check all fastening elements and retighten if necessary.
2.	Check all connecting elements and retighten if necessary.
3.	The inspection has been successful if: <ul style="list-style-type: none"> – all fastening elements are properly tightened. – all connecting elements are properly tightened.

7.2.8 Repairing the pumps

The following section explains how to repair the high-pressure pump:

	Description
Qualifications	Repair and service the high-pressure pump
Type of maintenance	Repair
Interval	as needed
Prerequisites	Clean, even work area with ample lighting
PPE	<ul style="list-style-type: none"> – Safety goggles – Protective gloves
Tools	<ul style="list-style-type: none"> – Cleaning rags – Cleaning product – Torch – Lubricant according to the drawing
1.	Disassemble the high-pressure pump.
2.	Clean the inside and outside of the high-pressure pump.

	Description
3.	Replace all seals and guide elements.
4.	Replace damaged high pressure pump components as necessary.
5.	Assemble the high-pressure pump. Apply a thin and even layer of lubricant to the following surfaces: <ul style="list-style-type: none">– Contact surfaces of seals and guide elements– Seals Specially designated areas must be treated according to drawing indications.
6.	Inspect and test the high-pressure pump. This includes the following maintenance work: <ul style="list-style-type: none">– 7.2.1 - System check– 7.2.5 - Leak test
7.	If the high-pressure pump has passed all tests, the repair is complete.



Maximator devices can be sent in for repairs to your local Maximator representative. All the necessary details are available on the Maximator website <http://www.maximator.de>

7.3 Spare parts and consumables



WARNING

Risk of injury due to inappropriate spare parts!

Making repairs using inappropriate spare parts can lead to accidents resulting in severe injuries or death.

- ▶ Only use spare parts that comply with Maximator specifications.

A list of the available spare parts, spare part kits and consumables can be found on the general drawing.

7.4 Accessories and special tools

A variety of special accessories are available for the high-pressure pump. Please let our sales department advise you.

The tools used for the products are continuously being updated and supplemented.

An overview of the currently available tools is accessible upon request when contacting the Maximator customer service.

7.5 Customer service

Our customer service is also at your disposal for technical details and repairs:

Address	Maximator GmbH Ullrichstraße 1-2 99734 Nordhausen Germany
Customer service phone Mon. – Thurs.: 06:30 – 16:15 CET Fri.: 06:30 – 14:00 CET	+49 3631 9533-5444
Fax	+49 3631 9533-5065
Email	service@maximator.de
Website	www.maximator.de/service

Feedback and experiences resulting from the application of our products and potentially leading to an optimisation of such are appreciated.

8 Troubleshooting

The following is a list of typical high-pressure pump faults, their causes, and the appropriate solutions.

If you experience any other specific or unexpected faults, please notify us at service@maximator.de

8.1 Drive side

Fault	Cause of fault	Solution
The high-pressure pump does not operate at low air pressure	Friction of the O-rings on the spool valve is too high	<ul style="list-style-type: none"> – Relubricate – Replace the O-rings on the spool valve
The high-pressure pump does not operate at low air pressure	O-rings will swell if the wrong oil or lubricant is used	<ul style="list-style-type: none"> – Replace the O-rings – Use lubricants according to the information on the drawing
High-pressure pump does not work	The control air is not connected	Connect the control air
The high-pressure pump does not operate, or operates slowly only.	The control air pressure is too low	The control air pressure must at least correspond to p_L
The high-pressure pump does not operate, or operates slowly only.	Ice has formed on the silencer or spool valve	Dehumidify the compressed air
The high-pressure pump does not operate, or operates slowly only.	Formation of residue in the silencer	Clean the silencers; replace it if necessary
The high-pressure pump does not work; air escapes via the silencer	The O-rings on the spool valve are defective	Replace and lubricate the O-rings
The high-pressure pump does not work; air escapes via the silencer	The O-ring on the air piston is defective or worn	Replace and lubricate the O-ring
The high-pressure pump does not work; air flows via the ventilation port of spool valve "V1"	The spool valve is jammed	<ul style="list-style-type: none"> – Clean the spool valve and sleeve – Check the O-rings and sleeves, and replace them if necessary – Lubricate
The high-pressure pump operates with high frequency and short strokes	The pilot valve in the top or bottom cap is defective	Clean, lubricate and, if necessary, replace the pilot valve

Tab. 8-1 Trouble shooting on the drive side

8.2 High pressure side

Fault	Cause of fault	Solution
The high-pressure pump operates without delivering the fluid, or it operates erratically. It does not reach the calculated discharge pressure.	Air in the hydraulic system	<ul style="list-style-type: none"> – Bleed the hydraulic system – Check connecting lines for leaks – Check seals
The high-pressure pump operates without delivering the fluid, or it operates erratically. It does not reach the calculated discharge pressure.	Suction line is too long	Shorten the suction line
The high-pressure pump operates without delivering the fluid, or it operates erratically. It does not reach the calculated discharge pressure.	The check valve is defective	Check the check valves, and replace them if necessary.
The high-pressure pump operates without delivering the fluid, or it operates erratically. It does not reach the calculated discharge pressure.	The suction filter is dirty	Clean / replace the suction filter
The high-pressure pump operates without delivering the fluid, or it operates erratically. It does not reach the calculated discharge pressure.	The HP seal is defective	Replace seal sets
Fluid escapes via one of the existing leak points.	Worn packing ring or HP seal	Replace seal sets

Tab. 8-2 Troubleshooting on the high-pressure side

9 Removal and disposal

9.1 Prerequisites for removal and disposal

Follow the manual and general drawing for the product.
In addition, the following conditions must be met:

- The product must be in a safe state.
- The product must be at ambient temperature.

9.2 Removal



WARNING

Risks of sustaining injuries are posed by improper handling of operating fluids!

Improper handling of operating fluids can lead to accidents resulting in severe injuries or death.

- ▶ Comply with the safety data sheets of the operating fluids.
 - ▶ Dispose of operating fluid residues in an appropriate manner.
 - ▶ Notify other people (for example: repair department) of hazardous operating fluids.
-



WARNING

Risk of sustaining injury posed while handling lubricants!

Handling lubricants may lead to accidents resulting in severe or fatal injuries.

- ▶ Use protective gloves and goggles.
 - ▶ Avoid contact with the skin.
 - ▶ Observe the safety data sheet of the lubricant accordingly.
-

To remove the high-pressure pump, carry out the following steps:

- Shut down the high-pressure pump.
- Depressurise the high pressure pump.
- Loosen the fastening screws and connections.
- Dismantle the high-pressure pump.

9.3

Disposal



WARNING

Risks of sustaining injuries are posed by improper handling of operating fluids!

Improper handling of operating fluids can lead to accidents resulting in severe injuries or death.

- ▶ Comply with the safety data sheets of the operating fluids.
- ▶ Dispose of operating fluid residues in an appropriate manner.
- ▶ Notify other people (for example: repair department) of hazardous operating fluids.

If the service life has expired: Send the product back to Maximator, postage paid, for proper disposal.

10 Use in explosion-prone zones

10.1 General information



High-pressure pumps bearing an ATEX label and delivered with a declaration of conformity with 2014/34/EU are suitable for use in potentially explosive atmospheres. They conform with equipment group II, equipment category 2G, explosion group IIB or IIC, structural safety. The designation is indicated on the rating plate and on the general drawing.

The individual parts of the label are explained below.

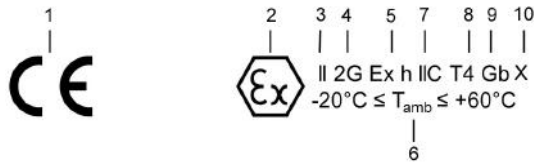

Fig. 10-1 Exemplary figure - ATEX label

- 1 CE symbol
- 2 Ex-symbol
- 3 Equipment group II: The high-pressure pump may be used in potentially explosive atmospheres, except in mining.
- 4 Equipment category 2G: The device ensures a high level of protection and may be used in Zone 1 and Zone 2.
- 5 Ex h marking: Designated for use as per DIN EN ISO 80079-36/37.
- 6 Designation of ambient temperature: Permissible range of ambient temperature.
- 7 Equipment group: Designated for use in potentially explosive gas atmospheres, with gases from Group IIB or IIC.
- 8 Temperature class or range of the temperature classes: Under compliance with the indications in the operating manual, device can be used in the temperature classes indicated.
- 9 EPL: Equipment in Group II for explosive zones generate vapours or mist due to mixing of air and gases; can be used in Zone 1 or 2; sufficient protection for normal operation and in case of foreseeable errors.
- 10 Additional designation X: The impact testing according to DIN EN ISO 80079-36 section 8.3.1 was carried out with a low level of mechanical risks.

10.2 Temperature class

The temperature of the high-pressure pump mainly depends on the temperature of the operating fluid.

The following table indicates the relationship of the operating fluid temperature and the temperature class of the high-pressure pump:

Max. temperature of operating fluid	Temperature class
60°C	T4
120°C	T3
Uncontrolled dry run ^a	T2

a. The pump is running dry for longer than 4 minutes.

Tab. 10-1 Temperature classes

The high-pressure pump must not be insulated. If it is nonetheless insulated, the equipment manufacturer must determine the temperature class of the equipment accordingly.

10.3 Operation and maintenance

Static electricity on the product can lead to explosions. This may result in severe or fatal injuries.

Never use high-power mechanisms for charge generation on or near the product.

All work on the pump, be it maintenance, cleaning or any other activity, must be carried out in the absence of an explosive atmosphere.

In order to ensure adequate safety during regular operation and in the event of foreseeable errors, the function of the high-pressure pump and compliance with the thresholds specified in these instructions must be monitored accordingly.

In doing so, the maintenance activities must be carried out at intervals that are appropriate for the application.

For safe operation, the devices may no longer be used after the leakage thresholds have been exceeded.

When the pump is started, it may run dry temporarily.

The device protection level does not change below the limits specified in the following.

- Limit the stroke frequency of the pump to 0.5 Hz to 1 Hz
- Suction lift to be observed
- Limit the duration of the dry run to 4 minutes

10.4 Summary of ignition hazards

Ignition hazard Source of ignition	Cause	Protective measure implemented
Hot surface	Heat generated by the operating fluid and friction	Definition of the temperature class Selection of the lubricant Specifications regarding the dry run Definition of maintenance work and intervals Definition of the compressed air quality Insulation not permitted
Mechanically generated sparks	Impact from the outside on the device	Selection of the materials For some devices: Restriction to a low level of mechanical risks
Mechanically generated sparks	Ignition caused by foreign objects that have entered	Prevent foreign objects from entering
Mechanically generated sparks	Ignition caused by dust in the equipment	Definition of maintenance intervals
Mechanically generated sparks	Impact from breakage of spring	Selection of the springs Ignitable drive media are prohibited
Flames	Ignition of operating fluids	Temperature class definition
Flames	Ignition of lubricants	Selection of the lubricants
Static electricity	Charging of insulated metal parts	All parts are conductively interconnected
Static electricity	Charging of non-conductive equipment parts	Design in accordance with component size specifications
Static electricity	Charging of non-conductive layers	Design in accordance with layer thickness specifications
Static electricity	Charging of non-conductive layers	Specifications regarding cleaning and handling of the pump
Static electricity	Charging due to powerful charge generating mechanisms	Exclusion of powerful charge generating mechanisms
Chemical reaction	Reaction between operating fluid and valve sections generates heat	Resistance of the valve materials must be checked.
External influence	Damage due to external influence	<ul style="list-style-type: none"> – Impact testing - For some devices: Restriction to a low level of mechanical risks – Decommissioning in case of damage

Tab. 10-2 Summary of the applicable ignition hazards identified and the protective measures implemented

Appendix

Appendix

The appendix comprises the following documents:

- EU Declaration of Conformity for the high-pressure pumps
- Incorporation Declaration for the high-pressure pumps

MAXIMATOR®

Maximum Pressure.

EU-Konformitätserklärung

Hiermit erklären wir, dass die Bauart von druckluftbetriebenen Hydraulikpumpen der Baureihen:

MO..., MO...D-, S..., S...D-, M..., M...D-, M...C, M...-2-, M...-3-, M...-ECO, M...-HL, S...-SS-, G...,
G...D-, G...-C, G...-2-, MSF..., GSF..., GPD..., GPD...-2, GX...

mit einer Seriennummer von 20000001 und höher

in der gelieferten Ausführung folgenden einschlägige Harmonisierungsrechtsvorschriften der Union:

EU-Richtlinie Explosionschutz 2014/34/EU

Angewendete harmonisierte Normen und technische Spezifikationen:

DIN EN ISO 12100:2011-03

DIN EN ISO 80079-36:2016-12

DIN EN ISO 80079-37:2016-12

Notifizierte Stelle eingeschaltet zur Aufbewahrung der Unterlagen nach 2014/34/EU:

0102 PTB - Braunschweig, (Bundesallee 100, 38116 Braunschweig)

Weitere einschlägige Bestimmungen: EG Maschinenrichtlinie (2006/42/EG) (Unvollständige Maschine)

Anschrift Hersteller: **MAXIMATOR GmbH, Lange Straße 6, 99734 Nordhausen / Deutschland**

Die alleinige Verantwortung für die Ausstellung dieser Konformitätserklärung trägt der Hersteller.

(Original)

EU Declaration of Conformity

Herewith, we declare that the model of air driven pumps type:

MO..., MO...D-, S..., S...D-, M..., M...D-, M...C, M...-2-, M...-3-, M...-ECO, M...-HL, S...-SS-, G...,
G...D-, G...-C, G...-2-, MSF..., GSF..., GPD..., GPD...-2, GX...

with a serialized ID of 20000001 and above

as supplied are in conformity with the relevant Union harmonisation regulations:

EU Explosion Protection Directive 2014/34/EU

Harmonised standards and technical specifications applied:

DIN EN ISO 12100:2011-03

DIN EN ISO 80079-36:2016-12

DIN EN ISO 80079-37:2016-12

Notified body involved for preserving the documents in compliance with 2014/34/EU:

0102 PTB - Braunschweig (Bundesallee 100, 38116 Braunschweig)

Further likewise applicable directives: Machinery directive (2006/42/EC) (partly completed machinery)

Name and address of manufacturer: **MAXIMATOR GmbH, Lange Straße 6, 99734 Nordhausen / Germany**

This declaration of conformity is issued under the sole responsibility of the manufacturer.

(Translation)

Nordhausen, den 18.05.2022 (Nordhausen, 18.05.2022)

.....
Stefen Roloff, (Divisionsleitung Components) (Division Manager Components)

MAXIMATOR® **Maximum Pressure.**

Einbauerklärung nach 2006/42/EG, Anhang II, Nr.1 B

Inhalt gemäß 2006/42/EG, Anhang II, Nr.1 B.

Anschrift Hersteller: **MAXIMATOR GmbH**
Lange Straße 6
99734 Nordhausen / Deutschland

Der Dokumentationsbeauftragte ist bevollmächtigt, die speziellen technischen Unterlagen nach Anhang VII B zusammenzustellen: dokumentationsbeauftragter@maximator.de / Tel.: 03631-9533-0

Die Bauart von Druckluftbetriebenen Hydraulikpumpen der Baureihe:

MO...-, MO...D-, S...-, S...D-, M...-, M...D-, M...-C, M...-2-, M...-3-, M...-ECO, M...-HL; S...-SS-, G...-, G...D-, G...-C, G...-2-, MSF...-, GSF...-, GPD...-, GPD...-2, GX...-, DPD...

mit einer Seriennummer von 20000001 und höher

ist eine unvollständige Maschine nach Artikel 2g und ausschließlich zum Einbau in oder zum Zusammenbau mit einer anderen Maschine oder Ausrüstung vorgesehen.

Grundlegende Sicherheits- und Gesundheitsschutzanforderung gemäß Anhang I dieser Richtlinie kommen zur Anwendung und wurden eingehalten :

Auflistung siehe separate Anlage

Die speziellen technischen Unterlagen gemäß Anhang VII B wurden erstellt und sie werden der zuständigen nationalen Behörde auf Verlangen in elektronischer Form übermittelt.

Diese unvollständige Maschine darf erst dann in Betrieb genommen werden, wenn festgestellt wurde, dass die Maschine, in die unvollständige Maschine eingebaut werden soll, den Bestimmungen der Maschinennichtlinie entspricht.

Declaration of Incorporation acc. to 2006/42/EC, Annex II, Nr.1 B

Contents acc. to 2006/42/EC, Annex II, Nr.1 B.

Name and address of manufacturer: **MAXIMATOR GmbH**
Lange Straße 6
99734 Nordhausen / Germany

The documentation officer is authorised to compile the relevant technical documentation as set forth in Annex VII B:

dokumentationsbeauftragter@maximator.de / Tel.: +49(0)3631-9533-0

The model of air driven liquid pumps type:

MO...-, MO...D-, S...-, S...D-, M...-, M...D-, M...-C, M...-ECO, M...-2-, M...-3-, S...-SS-, G...-, G...D-, G...-C, G...-2-, MSF...-, GSF...-, GPD...-, GPD...-2, GX...-, DPD...

with a serialized ID of **20000001** and above

is a partly completed machinery as defined in Article 2g and exclusively envisaged for installation into or assembly with other machinery or equipment.

Essential health and safety requirements (EHSR) acc. to Annex I to this directive have been applied and complied with: See separate Appendix

The relevant technical documentation according to Annex VII B was compiled and will be forwarded to the competent national authority in electronic form upon request.

The partly completed machinery must not be put into service until the final machinery into which it is to be incorporated has been declared in conformity with the provisions of the Directive on Machinery.

Nordhausen, den 21.08.2023 (Nordhausen, 31.08.2023)

.....

Steffen Roloff (Divisionsleitung Components) (Division Manager Components)

Appendix for the Declaration of Incorporation according to 2006/42/EC Appendix II, No. 1 B

Description of the basic safety and occupational health and safety requirements according to 2006/42/EC Appendix I to be applied and observed.

No.	Basic requirement	Applicable	Met	Comment
1.1	General information			
1.1.1	Definition	Yes	Yes	
1.1.2	Safety integration principles	Yes	Yes	
1.1.3	Materials and products	Yes	Yes	
1.1.4	Lighting	No		
1.1.5	Machine design regarding handling	Yes	Yes	
1.1.6	Ergonomics	No		
1.1.7	Operator's console	No		
1.1.8	Seats	No		
1.2	Controls and control devices			
1.2.1	Control safety and reliability	Yes	No	Unintended start-up
1.2.2	Actuators	No		
1.2.3	Starting the system	Yes	No	Unintended start-up Changing the operating state
1.2.4	Shut-down			
1.2.4.1	Normal shut-down	Yes	No	No control device for shut-down
1.2.4.2	Operational shut-down	No		
1.2.4.3	Emergency shut-down	Yes	No	No emergency stop
1.2.4.4	Completeness of machines	No		
1.2.5	Selection of control or operating modes	No		
1.2.6	Fault in the energy supply	Yes	No	Unintended start-up
1.3	Protective measures against mechanical hazards			
1.3.1	Risk of stability loss	Yes	No	Transport, repair
1.3.2	Risk of breakage during operation	Yes	Yes	
1.3.3	Risks posed by dropping or ejected objects	Yes	Yes	

Appendix

No.	Basic requirement	Applicable	Met	Comment
1.3.4	Risks posed by surfaces, edges and corners	Yes	Yes	
1.3.5	Risks posed by multiple machines combined	No		
1.3.6	Risks posed by changed usage conditions	No		
1.3.7	Risks posed by movable parts	Yes	Yes	
1.3.8	Selection of protective equipment against risks posed by movable parts	No		
1.3.9	Risk of uncontrolled movement	No		
1.4	Protective equipment requirements			
1.4.1	General requirements	No		
1.4.2	Special specifications for guards	No		
1.4.3	Special specifications for protective devices	No		
1.5	Risks posed by other hazards			
1.5.1	Electrical energy supply	No		
1.5.2	Static electricity	Yes	Yes	
1.5.3	Non-electrical energy supply	Yes	No	
1.5.4	Assembly fault	Yes	Yes	
1.5.5	Extreme temperatures	Yes	No	Equipment may heat up or cool down
1.5.6	Fire	Yes	Yes	
1.5.7	Explosion	Certified separately		
1.5.8	Noise	Yes	No	Depending on installation and application
1.5.9	Vibrations	No		
01/05/2010	Radiation	No		
01/05/2011	Radiation from the outside	Yes	Yes	
01/05/2012	Laser radiation	No		
01/05/2013	Emission of hazardous materials and substances	Yes	No	Release and leakage of operating fluid

No.	Basic requirement	Applicable	Met	Comment
01/05/2014	Risk of being locked into the machine	No		
01/05/2015	Risk of slipping, tripping or falling	No		
01/05/2016	Lightning strike	No		
1.6	Maintenance			
1.6.1	Machine maintenance	Yes	No	In context of the overall system
1.6.2	Access to the operator stations and access points for maintenance	No		
1.6.3	Disconnection of energy sources	Yes	No	Unavailable
1.6.4	Operating personnel interventions	Yes	Yes	
1.6.5	Cleaning of machine parts in the interior	No		
1.7	Information			
1.7.1	Information and warnings on the machine	No		
1.7.2	Warning of residual risks	Yes	No	In context of the overall system
1.7.3	Machine labels	Yes	Yes	
1.7.4	Operating manual	No		Installation manual
2-6	Additional requirements for specific machine types and hazards	No		

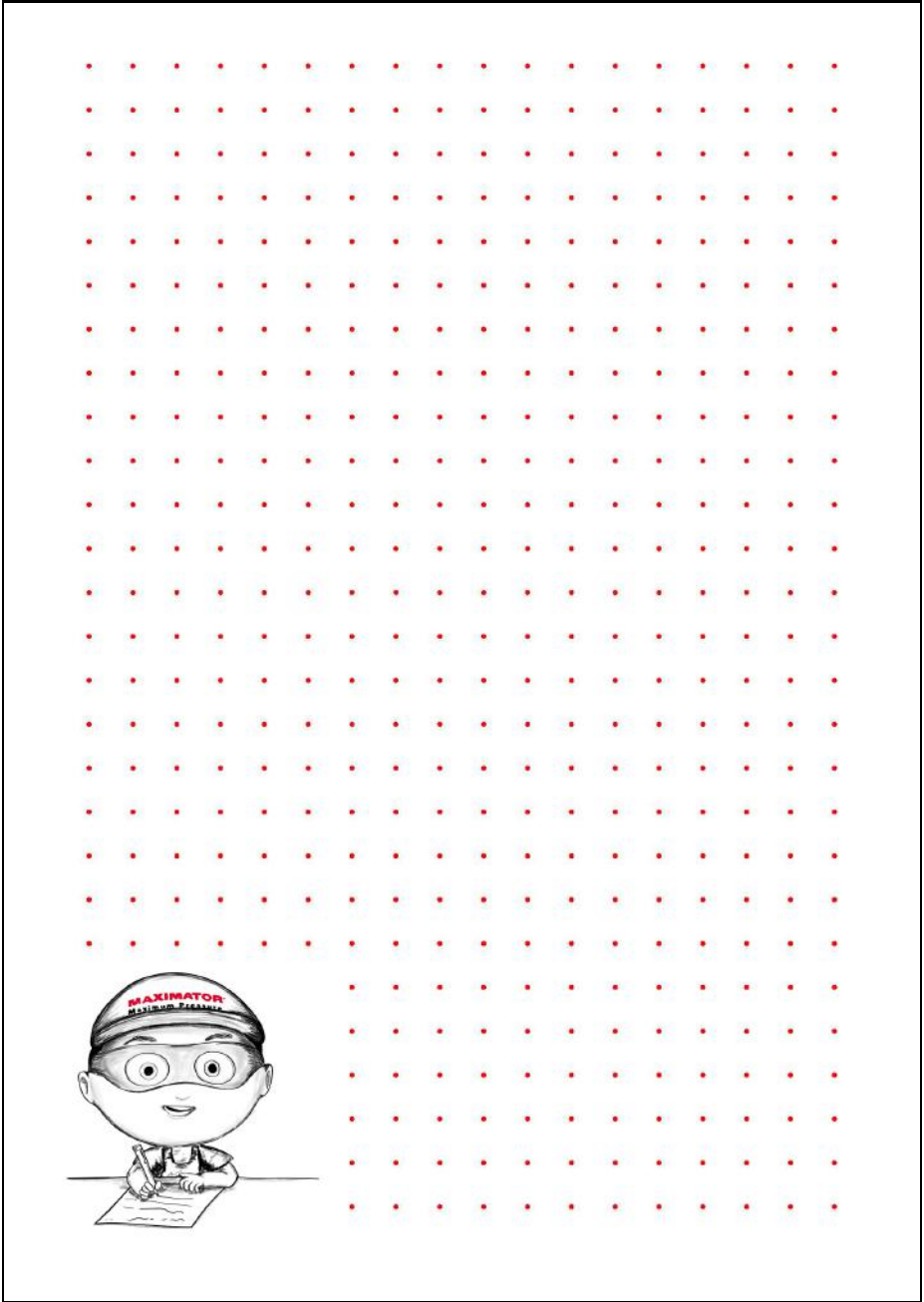

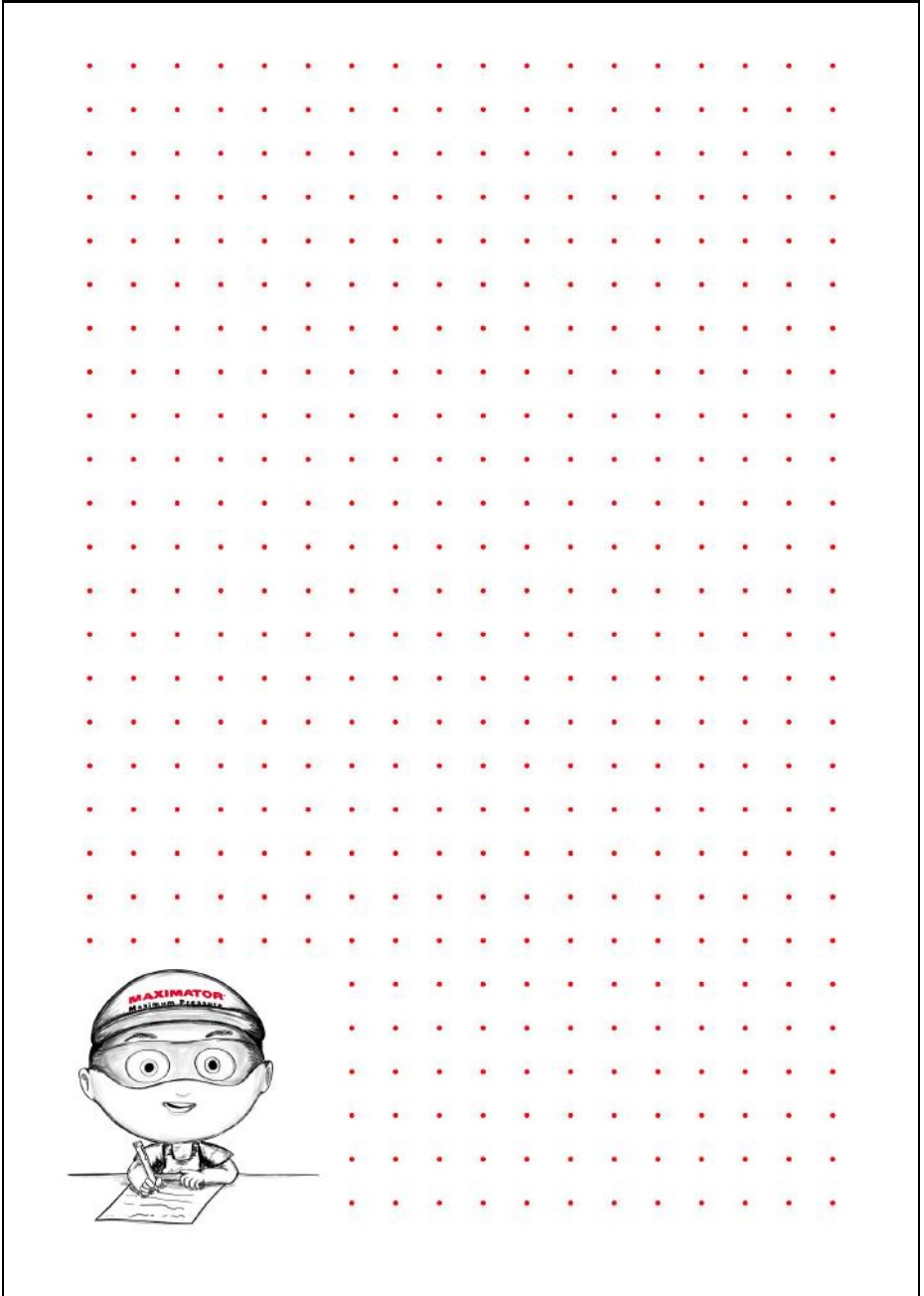

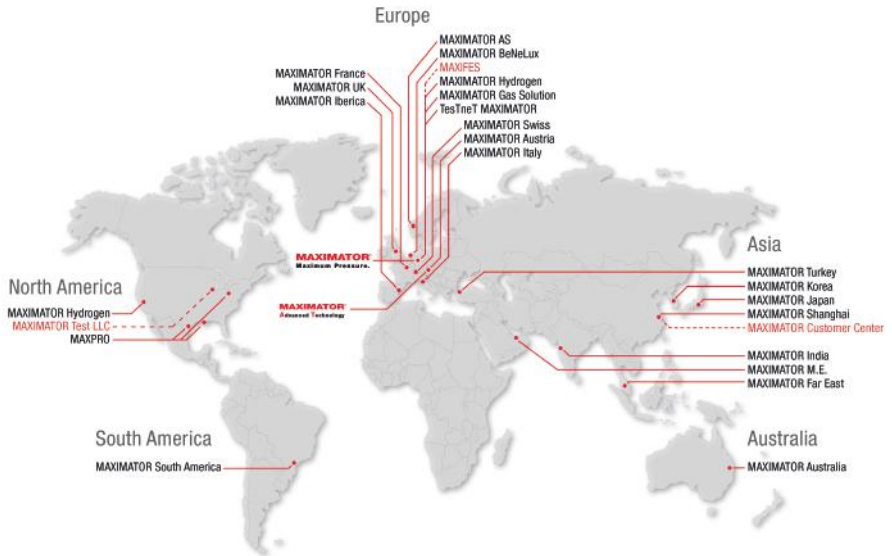

Visit our website at: www.maximator.de

Article number: 1999.3178